

GB

English, 1

GB

ISL60V

Contents

Installation, 2-3

- Where to put your dryer
- Ventilation
- Electrical connection
- Before you start using your dryer

Dryer description, 4

- The front
- The back
- Control panel

Start and programmes, 5-7

- Choosing a programme
- Table of programmes
- The controls

Laundry, 8-9

- Sorting your laundry
- Wash care labels
- Special clothing items
- Drying times

Warnings and Suggestions, 10

- General safety
- Disposal
- Saving energy and respecting the environment

Maintenance and Care, 11

- Switching off the electricity
- Cleaning the filter after each cycle
- Check the drum after each cycle
- Cleaning the dryer

Troubleshooting, 12

Service, 13

- Spare parts

Installation

GB

! Keep this instruction booklet on hand in order to refer to it when necessary. Take it with you when you move, and, should you sell this appliance or pass it on to another party, make sure that this booklet is supplied along with the dryer so that the new owner may be informed about warnings and suggestions on how the dryer works.

! Read these instructions carefully; the following pages contain important information on installation and suggestions on how the appliance works.

Where to put your dryer

- Place your dryer at a distance from gas ranges, stoves, heaters, or cook tops because flames can damage the appliance.
- If you are going to install the appliance under a work counter, be sure to leave a 10mm space between the top and any other objects on or above the machine and a 15mm space between the sides and lateral furnishings or walls. This is to ensure proper air circulation. Make sure that the back vents are not obstructed.
- Make sure you put your dryer in an environment that is not damp and has proper air circulation throughout.

Ventilation

The Dryer dries your laundry by drawing in cool, clean and relatively dry air, heating it, and then distributing it through the clothes as they are gently tumbled. For optimum performance, the moist air is then blown out through a vent tube at the back of the dryer.

When the dryer is in use, there has to be adequate ventilation to avoid the back flow of gases into the room from appliances burning other fuels, including open fires.

Mobile venting

A vent tube must always be fitted when the dryer is used in conjunction with Mobile Venting. The tube must be fitted securely into the back of the dryer (*see Dryer Description*). If possible, it is always best to connect the tube to a permanent outlet close to the dryer. If permanent installation is not possible, the dryer will work just as well with the tube passing through a partly-opened window.

! Ensure that the end of the tube is not directed toward the air intake vent at the rear of the dryer.

! The vent tube should not exceed 2.4 metres in length and should be kept free of any possible accumulation of fluff, lint and water by shaking it out frequently. Always ensure that the tube is not squashed.

Permanent venting

In conjunction with the vent tube we recommend using a Wall/Window Vent Kit, available at a retail location or the nearest Spare Parts Dealer.

Wall mounting

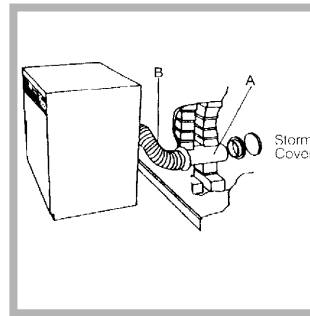

1. Leave an opening in the wall to the left of the dryers proposed position.
2. Keep the tube as short and straight as possible to prevent condensed moisture from backing up into the dryer.
3. Similarly, the duct in the wall should slope downwards towards the outside.

Window mounting

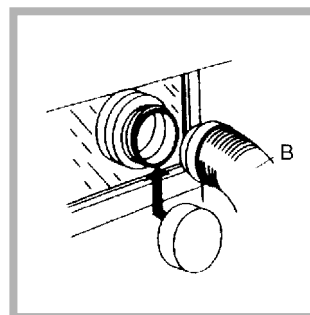

1. With a stacked dryer the hole in the window should ideally be made below the vent.
2. The tube should be kept as short as possible.

Depending on how often you use your dryer, it is essential that areas A and B are checked periodically to remove lint or debris.

The vent tube adaptor must be fitted securely thus preventing any humid air from being emitted back into the room.

! The Dryer should not be pushed so far back that the tube adaptor is pulled out of position or the tube is squashed or bent.

! The tube should be kept clear of the air intake vent and kinks or 'U' bends must be avoided as these will obstruct the tube or trap condensation.

Open window venting

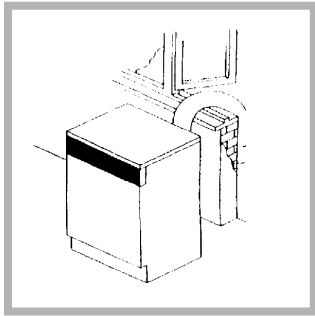

1. The end of the tube should be directed downwards, to prevent warm moist air from condensing in the room or in the dryer.

- ! Ensure that the dryer is adequately ventilated and that the end of the vent tube is not directed towards the air intake duct.
- ! The vent tube must always be fitted for optimum performance.
- ! Make sure that the vent tube and air intake vents are not obstructed or blocked.
- ! The dryer must not recycle exhaust air.
- ! Misusing a tumble dryer may create a fire hazard.
- ! Do not discharge exhaust air into a flue which is used for exhaust fumes from other appliances that burn gas or other fuels.

Electrical connections

Make sure of the following before you insert the plug into the the electrical socket:

- The socket must be grounded.
- The socket must be able to sustain the machines maximum power, which is indicated on the rating label (*see Dryer Description*).
- Power voltage must be within the values indicated on the rating label (*see Dryer Description*).
- The socket must be compatible with the dryers plug. Should this not be the case, replace the plug or the socket.

! The dryer must not be installed outdoors, even if the space is sheltered. It can be very dangerous if it is exposed to rain or storms.

! Once installed, the dryers electrical wire and plug must be within easy reach.

! Do not use extension cords.

! The power cord must not be bent or squashed.

! The power cord supplied is fitted with a BS1363 plug and a 13 amp BS1362 fuse. If you need to replace the fuse, use only those rated at 13 amp (13A) and ASTA approved to BS1362.

Moulded plug

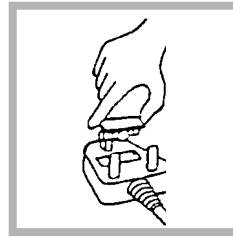

! The plug must not be used without the fuse cover in place. If a replacement fuse holder/cover is required, it must be of the same colour coding or wording as shown on the base of the plug. Replacements are available from authorised dealers.

Changing the plug

The wires in the power cord are coloured in accordance with the following:

GREEN / YELLOW - EARTH
 BLUE - NEUTRAL
 BROWN - LIVE

If a replacement plug is to be fitted, the appropriate wire must be connected to the correct terminal, as follows:

Green and Yellow (Earth) wire to terminal marked 'E', symbol \perp , or coloured green and yellow.

Blue (Neutral) wire to terminal marked 'N' or coloured black.

Cord clamp

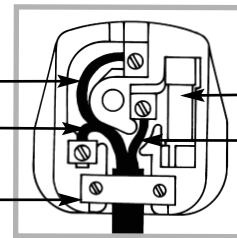

13A ASTA approved fuse to BS1362.

Brown (Live) wire to terminal marked 'L' or coloured red.

! If the plug being replaced is a non-rewirable type, then the cut-off plug must be disposed of safely. DO NOT leave it where it can be inserted into a socket and create a shock hazard.

! The power supply cord should be checked periodically and replaced by a cord specially prepared for this dryer and fitted only by authorised technicians (*see Service*). New or longer power cords are supplied at an extra charge by authorised dealers.

! The manufacturer denies any responsibility should any of these rules not be followed.

! If in doubt about any of the above consult a qualified electrician.

Before you start using your dryer

Once you have installed your dryer and before you use it, clean the inside of the drum to remove any dust that could have accumulated during transport.

GB

Installation

Description

Start and Programmes

Laundry

Warnings and Suggestions

Maintenance and Care

Troubleshooting

Service

Dryer Description

GB

The front

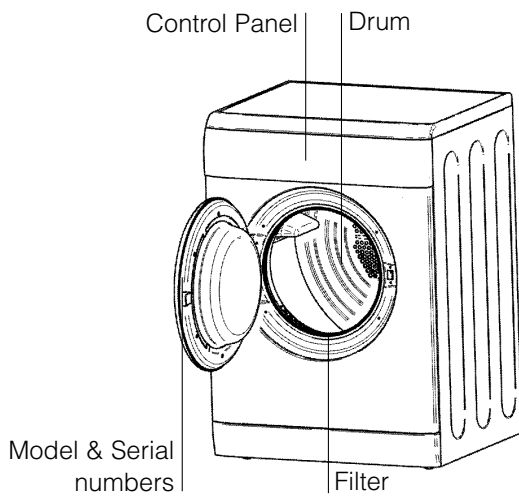

The back

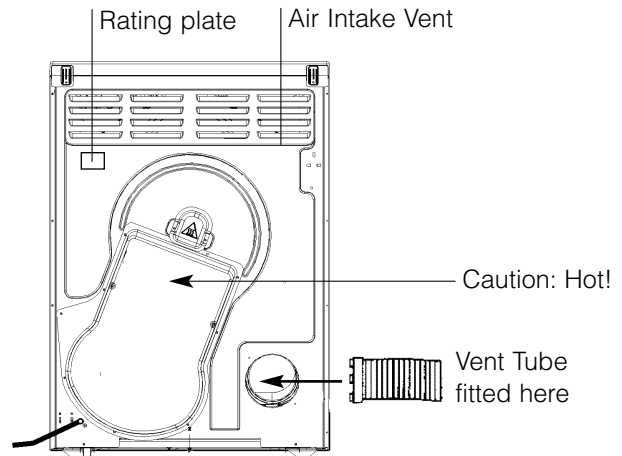

Control panel

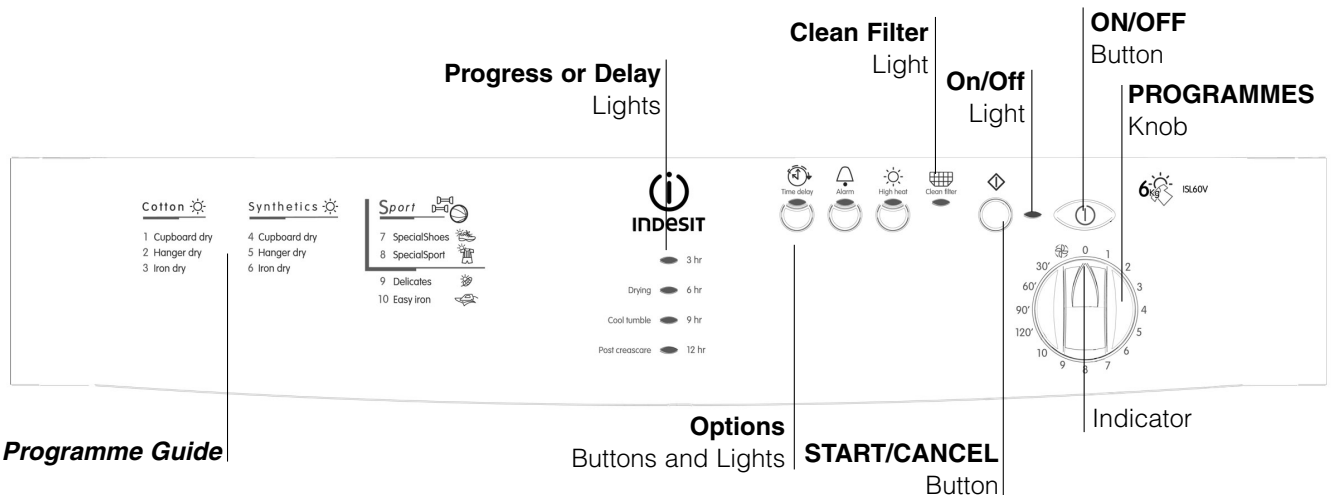



The **START/CANCEL** button  starts a selected programme. When you press this button there will be one beep and the progress lights will flash to confirm the action. If you have not set a programme, the buzzer will beep four times. When a programme is running, holding this button cancels the programme and stops the dryer (*see Start and Programmes*).

The **OPTION** buttons/lights select available options for your selected programme (*see Start and Programmes*). The lights indicate that the option has been selected.

The **Programme Guide** allows you to consult a user friendly table of the available programmes.

The **Clean Filter** light  gives you a reminder before every programme that it is essential to clean the filter every time the dryer is used (*see Maintenance and Care*).

The **On/Off** indicator light  signals that your dryer is in use or ready to select a programme. If this light flashes it indicates a fault (*see Troubleshooting*).

The **ON/OFF** button  : If the dryer is running and this button is pressed, the dryer stops. Press again, the dryer restarts.

The **Progress or Delay** lights show you the status of the programme or the delay time when they flash. During a delayed start the lights flash to show the delay selected. When (not flashing) they show each stage of the programme by the corresponding light turning on (*see Start and Programmes*).

The **PROGRAMMES** knob sets the programme: rotate it until the indicator is pointing to the programme you want to select (*see Start and Programmes*).

Choosing a programme

1. Plug the dryer into the electrical socket.
2. Sort your laundry according to fabric type (*see Laundry*).
3. Open the door and make sure the filter is clean and in place (*see Maintenance*).
4. Load the machine and make sure items are not in the way of the door seal. Close the door.
5. If the On/Off light is not lit: Press the ON/OFF button .
6. Choose a programme by checking the Programmes Guide (*see Programmes*) as well as the indications for each type of fabric (*see Laundry*).
- Select a programme by rotating the PROGRAMMES knob.
7. Set a delay time and other options if necessary.
8. If you wish to select the buzzer sound, at the end of the programme, press the ALARM Option button.
9. Press the START button to begin.

During the drying programme, you can check on your laundry and take out items that are dry while others continue drying. When you close the door again, press the START button in order to resume drying.

10. During the last few minutes of Drying Programmes, before the programme is completed, the final COOL TUMBLE phase is entered (fabrics are cooled), this phase should always be allowed to complete.
11. When the programme is complete. The buzzer will sound, if this option selected. Open the door, take the laundry out, clean the filter and replace it (*see Maintenance*). If you do not take out the laundry immediately, the dryer will tumble occasionally for 10 hours or until you open the door.
12. Unplug the dryer.

Easy Iron Programme

'Easy Iron' is a short 10 minute programme (8 minutes of heat followed by a 2 minute cool tumble period) which fluffs the fibres of clothing that have been left in the same position/location for an extended period of time. The cycle relaxes the fibres and makes them easier to iron and fold.

! 'Easy Iron' is **not a drying programme** and should not be used for wet articles of clothing.

For best results:

1. Do not load more than the maximum capacity.

These numbers refer to the dry weight:

Fabric	Maximum load
Cotton and Cotton mixtures	2.5kg
Synthetics	2kg
Denim	2kg

2. Unload the dryer immediately after the end of the programme, hang, fold or iron the articles and put them away in the closet. Should this not be possible repeat the programme.

The 'Easy Iron' effect varies from one fabric to the next. It works well on traditional fabrics like Cotton or Cotton mix, and less well on acrylic fibres and on materials such as Tencel®.

Sport programme

Special shoes

- This is a programme to dry one pair of sports shoes sized 37-46 (4-11).
 - The shoes must have been washed and spun at a minimum spin speed of 400rpm.
 - They must be used with the shoe rack provided. If you tumble shoes in the drum you will damage your dryer.
 - Remove the filter from its position in the front of the dryer and fit the rack.
 - Tuck the laces inside the shoes and load shoes with toes down and soles facing you.
 - Drying times will vary dependant on the size and style of shoe. If shoes are not completely dry at the end of the programme, run the programme again.
- !** Do not dry shoes with Gel inserts or flashing lights.
! Only dry shoes made from Synthetics or Canvas materials.
! When finished remove shoe rack and **replace the filter**.

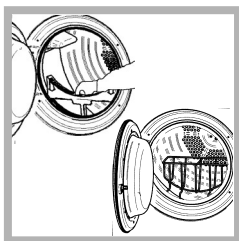

Special sports

- This is a programme for tumble dryer safe garments, such as Tracksuits and Shorts marked with the symbol .
- It can be used for load sizes up to 1.5kg
- We recommend that garments are turned inside out before drying.
- This programme will take up to 130 minutes. The actual time will vary depending on the size and density of the load and the spin speed used in your washer.
- Loads dried using this programme are usually ready to wear, but on some heavier garments the edges may be slightly damp.

GB

Installation

Description

Start and Programmes

Laundry

Warnings and Suggestions

Maintenance and Care

Troubleshooting





















































Service

Start and Programmes

GB

Programmes

! If the On/Off light is not lit; Press the ON/OFF button  and then select programme.

Programme	What it does...	How to set it..	Note:
1 Cottons  Cupboard Dry 	Dries your clothes on High heat setting, ready for putting away	1. Position the PROGRAMME knob on 1 . 2. Select any Options, if required. 3. Press the START button  .	Options available: Alarm  Delayed start 
2 Cottons  Hanger Dry 	Dries your clothes on High heat setting, ready for hanging.	1. Position the PROGRAMME knob on 2 . 2. Select any Options, if required. 3. Press the START button  .	Options available: Alarm  Delayed start 
3 Cottons  Ready to Iron 	Dries your clothes on High heat setting, ready for ironing.	1. Position the PROGRAMME knob on 3 . 2. Select any Options, if required. 3. Press the START button  .	Options available: Alarm  Delayed start 
4 Synthetics  Cupboard Dry 	Dries your clothes on High heat setting, ready for putting away.	1. Position the PROGRAMME knob on 4 . 2. Select any Options, if required. 3. Press the START button  .	Options available: Alarm  Delayed start 
5 Synthetics  Hanger Dry 	Dries your clothes on High heat setting, ready for hanging.	1. Position the PROGRAMME knob on 5 . 2. Select any Options, if required. 3. Press the START button  .	Options available: Alarm  Delayed start 
6 Synthetics  Ready to Iron 	Dries your clothes on High heat setting, ready for ironing.	1. Position the PROGRAMME knob on 6 . 2. Select any Options, if required. 3. Press the START button  .	Options available: Alarm  Delayed start 
7 Special Shoes 	Dries your shoes on Low heat setting, ready to be worn (<i>see previous page</i>).	1. Position the PROGRAMME knob on 7 . 2. Select any Options, if required. 3. Press the START button  .	Options available: Alarm 
8 Special Sports 	Dries your sports clothes on Low heat setting, ready to be worn (<i>see previous page</i>).	1. Position the PROGRAMME knob on 8 . 2. Select any Options, if required. 3. Press the START button  .	Options available: Alarm  Delayed start 
9 Delicate  eg. Acrylics	Dries your clothes on Low heat setting, ready to be worn.	1. Position the PROGRAMME knob on 9 . 2. Select any Options, if required. 3. Press the START button  .	Options available: Alarm  Delayed start 
10 Easy Iron 	Brief programme (approximately 10 minutes) that softens fibres of clothing that is ready for ironing.	1. Position the PROGRAMME knob on 10 . 2. Select any Options, if required. 3. Press the START button  .	! This is not a drying programme (<i>see previous page</i>). Options available: Alarm 
Timed Drying (120, 90, 60 or 30 minutes)	Dries wet clothing that you wish to dry on low heat or small loads (less than 1kg). Can be used with high heat option if you prefer to use a timed programme.	1. Position the PROGRAMME knob on the desired time: 120, 90, 60 or 30 . 2. Select any Options, if required. 3. Press the START button  .	Options available: Alarm  , High Heat  , Delayed Start  Consult suggested drying times (<i>see Laundry</i>). The last 10 minutes of these programmes is the Cool Tumble (<i>see below</i>).
Cool Tumble 	Brief programme (approximately 10 minutes) that cools fibres or clothing.	1. Position the PROGRAMME knob on  2. Select any Options, if required. 3. Press the START button  .	Options available: Alarm 

The Controls

• PROGRAMMES knob

! Warning, if after pressing the start button, the programmes knob position is changed, the new position will **NOT** change the programme selected.

! Position 0, turning the knob to position 0 resets and cancels a programme.

• OPTION buttons / lights

These buttons are used to customise the selected programme to your requirements. A programme must have been selected on the programme knob before an option can be selected. Not all options are available for all programmes (*see Start and Programmes*). If an option is not available and you press the button, the buzzer will beep four times. If the option is available there will be one beep and the option light above the button lights to confirm the selection. After the start button has been pressed only the Alarm option can be changed.

Progress (Drying, Cool Tumble, Post Creasecare) / Delay (3hr 6hr 9hr 12hr) Lights

When the light above the delay button is on, these lights flash to indicate the delay time is selected. During other programmes they indicate the progress of the dryer, each one comes on as the corresponding phase starts.

Time Delay

The start of some programmes (*see Start and Programmes*) can be delayed for up to 12 hours in 3hr steps.

When a delayed start is in progress the light above the delay button will be on and the selected delay period light will flash (after the start button has been pressed).

To set a delayed start, press the Time Delay button, and the light above the button will come on together with the 3hr delay light. Pressing the button again will advance the delay setting to 6hr, the 3hr light goes out and the 6hr light is on. Each time you press the button the delay setting advances 3 hours, as indicated by the corresponding light. If the 12hr light is on, pressing the button again will cancel the delay.

You can also cancel the delay by turning the programmes knob to 0, wait for the buzzer to beep and then turn back to your selected programme.

Pre Creasecare

When a delayed start has been selected, the clothes are tumbled occasionally during the delayed period to help prevent creases developing.

High Heat

When available this button selects high heat. Press this button and a high heat setting is selected and the light above the button comes on. Timed programmes have a default of low heat, if the light alongside the button is on then pressing the button selects a low heat setting and the light goes out.

Alarm

Available on all programmes and allows the buzzer to give a signal at the end of the drying cycle, to remind you that the clothes are ready to be removed. Press the button and the light will show that the option is selected.

Post Creasecare

The clothes are occasionally tumbled after the end of the drying and cool tumble cycles, to help prevent creases developing should you not be available to remove the load immediately the programme is complete.

• Door Opening

Opening the door during a programme will stop the dryer and have the following effects:

- All 3 progress lights and the 3hr delay light come on.
- During a delay phase the delay will continue to count down. The start button **must** be pressed to resume the delay programme. One of the delay lights will flash to show the current delay setting.
- The start button **must** be pressed to resume the programme. The progress lights will change to show the current status.
- During the cool tumble or post creasecare phase of a drying programme and anytime during an Airing or Cool Tumble programme, the programme will finish. Pressing the start button will re-start a new programme at the beginning.
- Changing the programmes knob will select a new programme, after you press the start button. You can use this to select the Cool Tumble programme to cool the clothes, if you find them dry enough.

• Note

If you have a power cut, switch off the power or remove the plug, press the START button and the programme will resume.

GB

Installation

Description

Start and Programmes

Laundry

Warnings and Suggestions

Maintenance and Care

Troubleshooting

Service

Laundry

GB

Sorting your laundry

- Check symbols on clothing labels to make sure that the articles can be tumble dried.
- Sort laundry by fabric type.
- Empty pockets and check buttons.
- Close zippers and hooks and tie loose belts and strings.
- Wring out each item in order to eliminate as much excess water as possible.

! Do not load dripping wet clothes into the dryer.

Maximum load size

Do not load more than maximum capacity.

These numbers refer to dry weight:

Natural fibres: 6kg max (13lb)

Synthetic fibres: 3kg max (6.6lb)

! DO NOT overload the dryer as this could result in reduced drying performance.





Typical load

Clothes			
Blouse	Cotton	150g	5oz
	Other	100g	3oz
Dress	Cotton	500g	1lb 2oz
	Other	350g	12oz
Jeans		700g	1lb 6oz
10 nappies		1000g	2lb 3oz
Shirt	Cotton	300g	10oz
	Other	200g	7oz
T-Shirt		125g	4oz
Household Items			
Duvet cover (Double)	Cotton	1500g	3lb 5oz
	Other	1000g	2lb3oz
Large Tablecloth		700g	1lb 6oz
Small Tablecloth		250g	9oz
Tea Towel		100g	3oz
Bath Towel		700g	1lb 6oz
Hand Towel		350g	12oz
Double Sheet		500g	1lb 2oz
Single Sheet		350g	12oz

At the end of a drying cycle, cottons could still be damp if you grouped cottons and synthetics together. If this happens simply give them an additional short period of drying.

Wash Care Labels

Look at the labels on your garments, especially when tumble drying for the first time. The following symbols are the most common:

-  May be tumble dried
-  Do **not** tumble dry
-  Tumble dry at high heat setting
-  Tumble dry at low heat setting

Items not suitable for tumble drying

- Articles that containing rubber or rubber-like materials or plastic film (pillows, cushions, or PVC rainwear), any other flammable articles or objects that contain flammable substances (towels soiled with hair spray).
- Glass fibres (certain types of draperies)
- Items which have been dry cleaned
- Items with the ITCL Code  (*see Special clothing items*). These can be cleaned with special at-home dry cleaning products. Follow instructions carefully.
- Large bulky items (quilts, sleeping bags, pillows, cushions, large bedspreads etc). These expand when drying and would prevent airflow through the dryer.

Special clothing items

Blankets and Bedspreads: acrylic items (Acilan, Courtelle, Orion, Dralon) **must be dried** with special care on LOW heat setting. Avoid drying for a long period of time.

Pleated or creased garments: read the manufacturer's drying instructions on the garment.

Starched articles: do not dry these with non-starched items. Make sure that as much of the starch solution is removed from the load as possible before placing it in the dryer. Do not over-dry: the starch will become powdery and leave your clothing limp, which defeats the purpose of starch.

Drying times

The table below presents APPROXIMATE drying times in minutes. Weights refer to dry garments:

Cottons					
High (full) Heat					
Drying times 800-1000rpm in washing machine					
		Half Load			Full Load
1kg	2kg	3kg	4kg	5kg	6kg
20-30	35-45	45-60	60-70	70-80	80-100
Synthetics					
High (full) Heat					
Drying times on reduced spin in washing machine					
	Half Load				Full Load
1kg	2kg				3kg
20-40	30-50				40-70
Delicates (e.g.Acrylics)					
Low (gentle) Heat					
Drying times on reduced spin in washing machine					
Half Load				Full Load	
1kg				2kg	
50-70				90-130	

Times are approximate and can vary depending upon:

- Amount of water retained in clothes after spin cycle: towels and delicates retain a lot of water.
- Fabrics: items that are the same type of fabric but different textures and thicknesses may not have the same drying time.
- Quantity of laundry: single items or small loads may take longer to dry.
- Dryness: If you are going to iron some of your clothes, they can be taken out while still a bit damp. Others can be left longer if you need them to be completely dry.
- Heat setting.
- Room temperature: if the room where the dryer is located is cold, it will take longer for the dryer to dry your clothes.
- Bulk: some bulky items can be tumble dried with care. We suggest that you remove these items several times, shake them out, and return them to the dryer until finished.

! Do not over-dry your clothes.

All fabrics contain a little natural moisture, which keeps them soft and fluffy.

GB
Installation
Description
Start and Programmes
Laundry
Warnings and Suggestions
Maintenance and Care
Troubleshooting
Service

Warnings and Suggestions

GB

! The appliance has been designed and built according to international safety standards. These warnings are given for safety reasons and must be read carefully.



This appliance conforms to the following EEC Directives:

- 72/23/EEC and 93/68/EEC (Low Voltage Equipment)
- 89/336/EEC, 92/31/EEC and 93/68/EEC (Electromagnetic Compatibility)

General safety

- This tumble dryer has been designed for home, and not professional use.
- This dryer must be used by adults, and the instructions in this booklet should be followed carefully.
- Do not touch the appliance while barefoot or with wet hands or feet.
- Unplug the machine by pulling on the plug, not the cord.
- Children must not be in proximity of the dryer when in use. After using the dryer, turn it off and unplug it. Keep the door closed to make sure that children do not use it as a toy.
- The appliance must be installed correctly and have proper ventilation. The air intake vents behind the machine, the outlet vents and the vent tube should never be obstructed (*see Installation*).
- Never direct the vent tube outlet vent towards the air intake at the back of the machine.
- Never allow the tumble dryer to recycle exhaust air.
- Never use the dryer on carpeting where the pile height would prevent air from entering the dryer from the base.
- Check to see if the dryer is empty before loading it.
-  The back of the dryer could become very hot. Never touch it while in use.
- Do not use the dryer unless the filter is securely in place (*see Maintenance*).
- Do not use fabric softeners or dryer sheets in the dryer.
- Do not overload the dryer (*see Laundry*) for maximum loads.
- Do not load items that are dripping wet.
- Tumble dry items only if they have been washed with detergent and water, rinsed and been through the spin cycle. It is a fire hazard to dry items that HAVE NOT been washed with water.
- Carefully check all instructions on clothing labels (*see Laundry*).
- Do not dry garments that have been treated with chemical products.
- Never dry articles that are contaminated with flammable substances (petrol, oil, paint, hair spray, creams, cooking fat or oils).
- Do not tumble dry rubber, foam rubber, plastic, plastic foam, nappy pants or liners, polythene or paper.
- Do not tumble dry large, very bulky items.
- Do not tumble dry acrylic fibres at high temperatures.
- Complete each programme with its Cool Tumble Phase.
- Do not turn off the dryer when there are still warm items inside.
- Clean the filter after each use (*see Maintenance*).
- Do not allow lint to collect around the dryer.
- Never climb on top of the dryer. It could result in damage.
- Always follow electrical standards and requirements (*see Installation*).
- Always buy original spare parts and accessories (*see Service*).

Disposal

- Disposing of the packaging material: follow local regulations, so the packaging can be recycled.
- Disposal of your old dryer: cut the power cord and remove the door before disposing of an old dryer.

Saving energy and respecting the environment

- Wring out items to eliminate excess water before tumble drying (if you use a washing machine first, select a high spin cycle). Doing this will save time and energy during drying.
- Always dry full loads - you save energy: single items or small loads take longer to dry.
- Clean the filter after each use to contain energy consumption costs (*see Maintenance*).

Switching off the electricity

Unplug your dryer when not using it, when cleaning it and during all maintenance operations.

Clean the filter after each cycle

The filter is an important part of your dryer: it accumulates lint and fluff that is formed while drying.

Small items could also become trapped in the filter. When finished drying, therefore, clean the filter by rinsing it under running water or with your vacuum cleaner. Should the filter become clogged up, the air-flow inside the dryer will be seriously compromised: drying times lengthen and you will consume more energy. It may also damage your dryer.

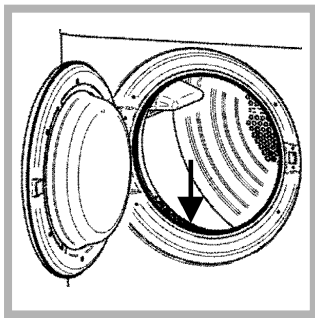

The filter is found in front of the dryer trim (see diagram).

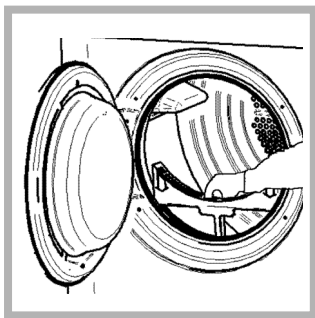

Removing the filter:
1. Pull the plastic grip of the filter upwards (see diagram).

2. Clean the filter and replace it correctly. Ensure the filter is fully located flush into the tumble dryer trim.

! Do not use the dryer without replacing the filter.

Check the drum after each cycle

Turn the drum manually in order to remove small items (handkerchiefs) that could have been left behind.

Cleaning

- External parts in metal or plastic and rubber parts can be cleaned with a damp cloth.
- Periodically check the vent tube and any permanent venting fixture to make sure that there has been no accumulation of fluff or lint, and remove it.
- Periodically clean the surface of the stainless steel sensor inside the drum with vinegar to remove water contaminates. Apply carefully with a cloth, this will maintain the drying performance of the dryer. The sensor is located on the plastic vane inside the drum towards the front of the dryer. Rotate the drum if necessary to locate it.
- Remove lint that collects around the filter and the outlet vents.

! Do not use solvents or abrasives.

! Your dryer uses special bearing components which do not need lubrication.

! Have your dryer checked regularly by authorised technicians to ensure electrical and mechanical safety (see Service).

GB
Installation
Description
Start and Programmes
Laundry
Warnings and Suggestions
Maintenance and Care
Troubleshooting
Service

Troubleshooting

GB

One day your dryer seems not to be working. Before you call your Service Centre (*see Service*), go through the following troubleshooting suggestions:

Problem:

Possible causes / Solution:

The tumble dryer won't start.

- The plug is not plugged into the socket, or not making contact.
- There has been a power failure.
- The fuse has blown. Try to plug another appliance into the socket.
- You are using an extension cord? Try to plug the dryer's power cord directly into the socket.
- The door is not closed securely?
- The PROGRAMMES knob has not been set properly (*see Start and Programmes*).
- The START button has not been pressed (*see Start and Programmes*).

Drying cycle will not begin.

- You have set a delayed time (*see Start and Programmes*).

Its taking a long time to dry.

- The filter has not been cleaned (*see Maintenance*).
- The correct programme has not been selected for the load (*see Start and Programmes*).
- The flexible vent tube is obstructed (*see Installation*).
- The air intake vent is obstructed (*see Installation*).
- The permanent ventilation flap on the storm cover is obstructed (*see Installation*).
- The items were too wet (*see Laundry*).
- The dryer was overloaded (*see Laundry*).

Programme finishes and clothes are damper than expected.

! For safety the dryer has a maximum programme time of 3 hours. If an automatic programme has not sensed the required final moisture in this time the dryer will complete the programme and stop. Check the above points and run the programme again, if the results are still damp, contact the Service Centre (*see Service*).

The ON/OFF light flashes to indicate a fault.

- Note down the code and contact the Service Centre (*see Service*).

Before calling the Service Centre:

- Use the troubleshooting guide to see if you can solve the problem yourself (*see Troubleshooting*).
- If not, turn off the dryer and call the Service Centre closest to you.

What to tell the Service Centre:

- name, address and post code.
- telephone number.
- the type of problem.
- the date of purchase.
- the appliance model (Mod.).
- the serial number (S/N).

This information can be found on the data label inside the door of the machine.

Spare Parts

This dryer is a complex machine. Repairing it yourself or having a non-authorized person try to repair it could cause harm to one or more persons, could damage the machine and could invalidate the spare parts warranty.

Call an authorised technician if you experience problems while using the machine.

The spare parts have been designed exclusively for this appliance and not for other uses.

GB
Installation
Description
Start and Programmes
Laundry
Warnings and Suggestions
Maintenance and Care
Troubleshooting
Service

195042597.00

09/2004 - SIMLEX . Four Ashes, Wolverhampton